

# 8"-504 WITH TNA OPERATOR AND 2" NUT

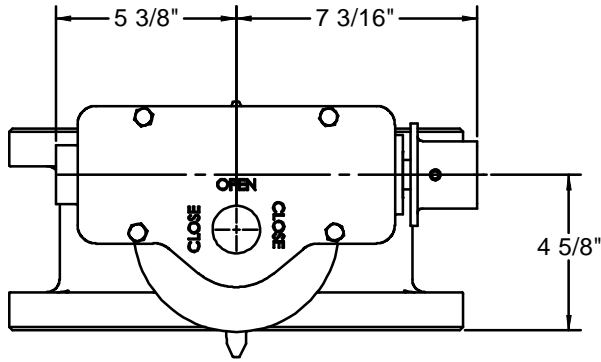

◆ OPTIONAL CONFIGURATION

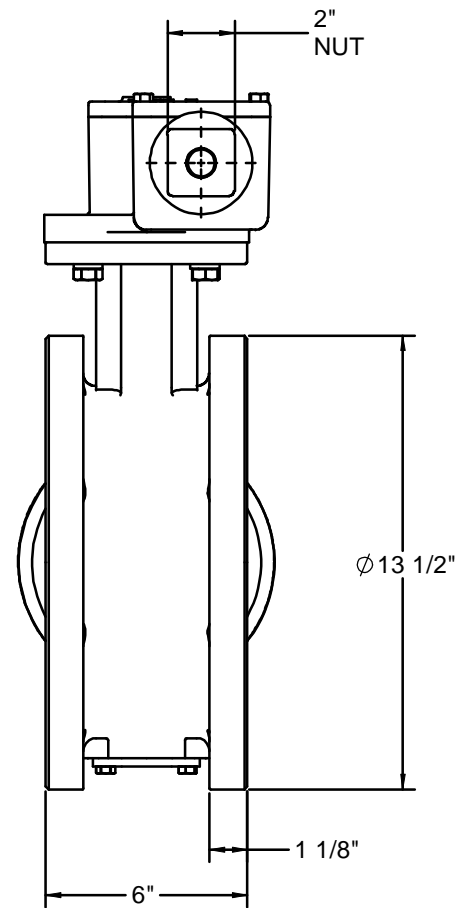
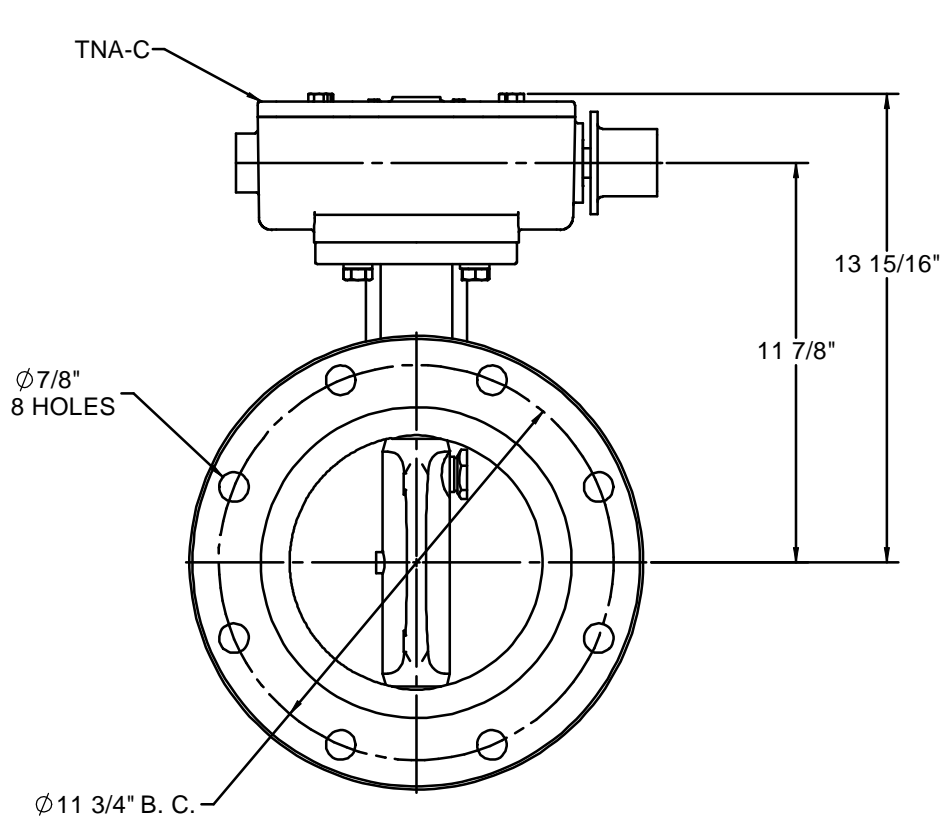
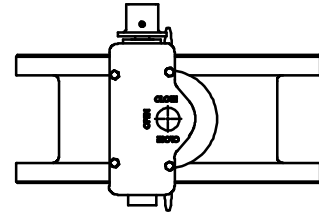

**NOTES:**

1. 150 PSIG MAXIMUM WORKING PRESSURE.
2. THIS VALVE CONFORMS TO AWWA C504.
3. FLANGES AND DRILLING PER ANSI 16.1 CLASS 125.
4. ASTM A126 GL. B CAST IRON BODY.  
ASTM A351-CF8M TYPE 316 STAINLESS DISC.  
ASTM A276 TYPE 304 STAINLESS STEEL SHAFT.
5. VALVE IS DESIGNED FOR BI-DIRECTIONAL FLOW.
6. VALVE MAY BE INSTALLED WITH SHAFT IN EITHER HORIZONTAL OR VERTICAL POSITION.
7. ALL DIMENSIONS ARE IN INCHES.
8. VALVE EXTERIOR WILL BE COATED WITH 8 MILS EPOXY.

REDRAWN:	
CHECKED:	
DRAWN: C. GEARY	02/24/09

<b>K-FLO</b> BUTTERFLY VALVES BY CRISPIN VALVES		
8"-504 SERIES BUTTERFLY VALVE TNA OPERATOR		
SIZE	08-504 TNA	REV 0