

12"-506HP WITH TNA OPERATOR AND 2" NUT

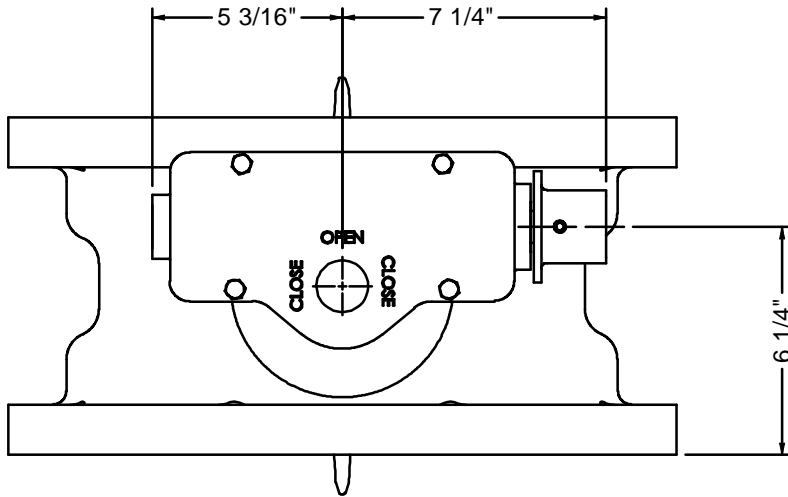

◆ OPTIONAL CONFIGURATION

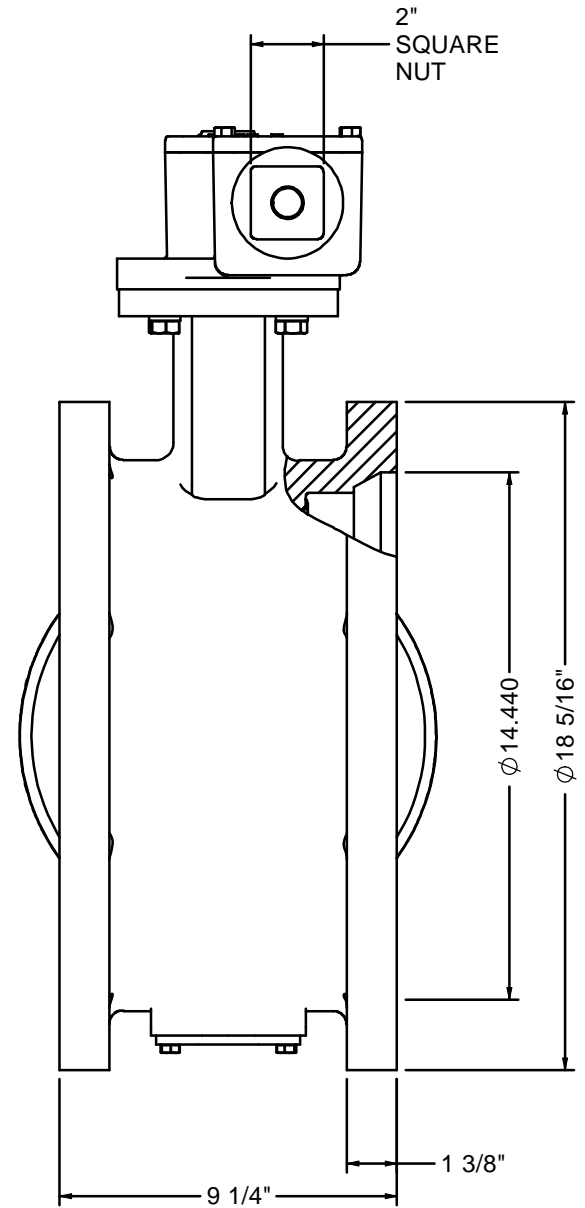
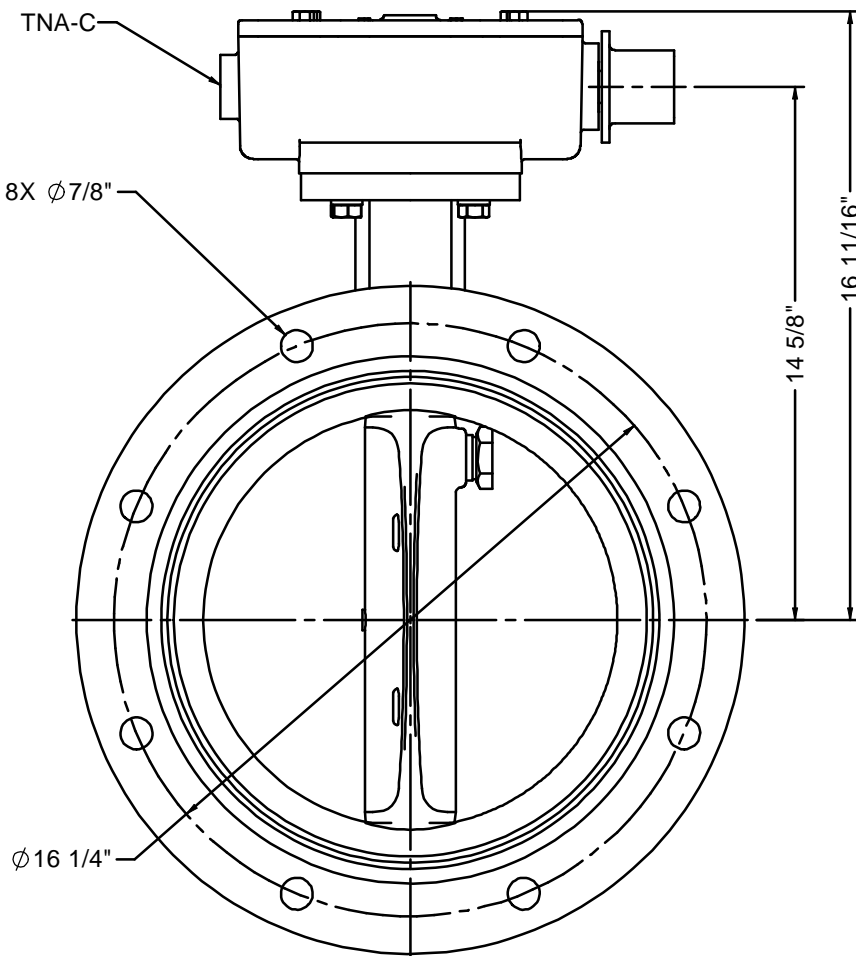
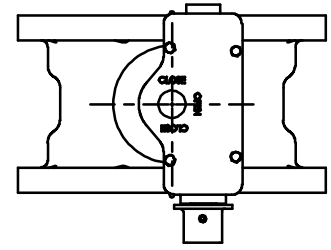

NOTES:

1. 250 PSIG MAXIMUM WORKING PRESSURE.
2. THIS VALVE CONFORMS TO AWWA C504.
3. MECHANICAL JOINT CONNECTION PER ANSI C111 AND AWWA A21.11.
4. ASTM A536 GR. 65-45-12 DUCTILE IRON BODY.
ASTM A536 GR. 65-45-12 DUCTILE IRON DISC WITH 316 SST EDGE.
ASTM A564 TYPE 630 (17-4PH) STAINLESS STEEL SHAFT.
5. VALVE IS DESIGNED FOR BI-DIRECTIONAL FLOW.
6. VALVE MAY BE INSTALLED WITH SHAFT IN EITHER HORIZONTAL OR VERTICAL POSITION.
7. ALL DIMENSIONS ARE IN INCHES.
8. VALVE DISC AND EXTERIOR WILL BE COATED WITH 8 MILS EPOXY.

K-FLO
 BUTTERFLY VALVES
 BY
 CRISPIN VALVES
 12"-506HP SERIES
 VALVE
 TNA OPERATOR

REDRAWN:		SIZE	DWG. NO.	REV
CHECKED:		C	12-506HP TNA	0
DRAWN: C. GEARY	02/13/05			