

14"-506HP WITH TNA OPERATOR AND HANDWHEEL

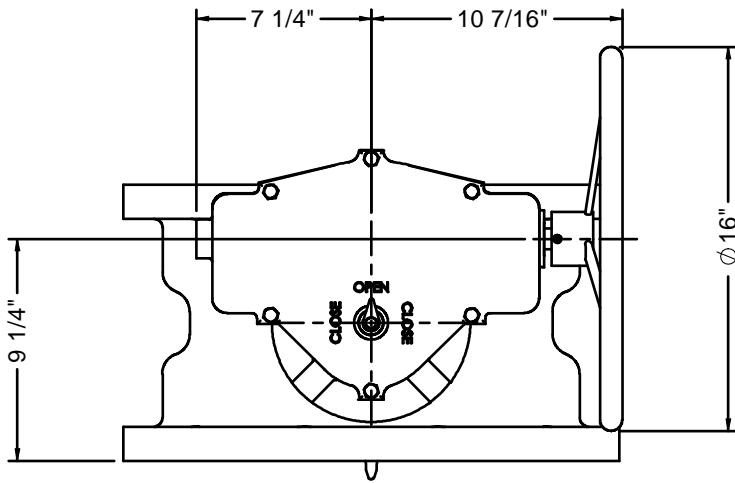

◆ OPTIONAL CONFIGURATION

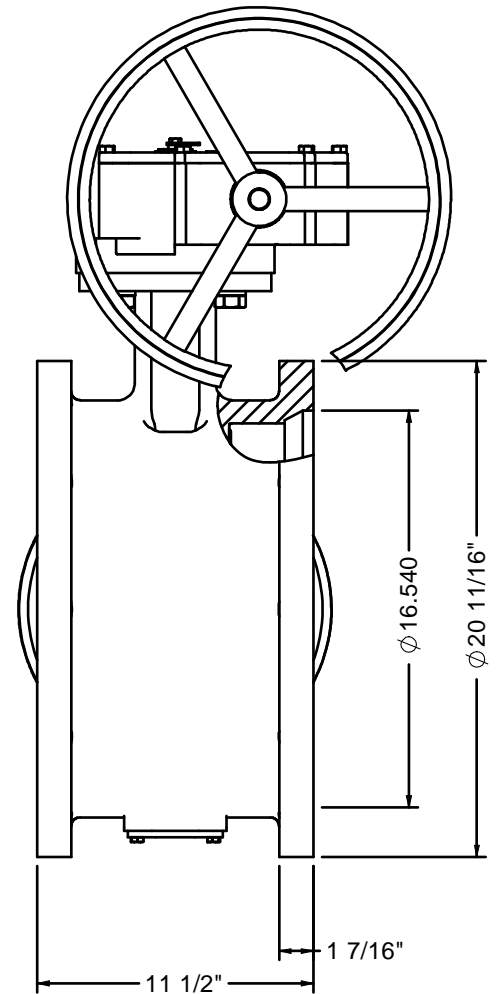
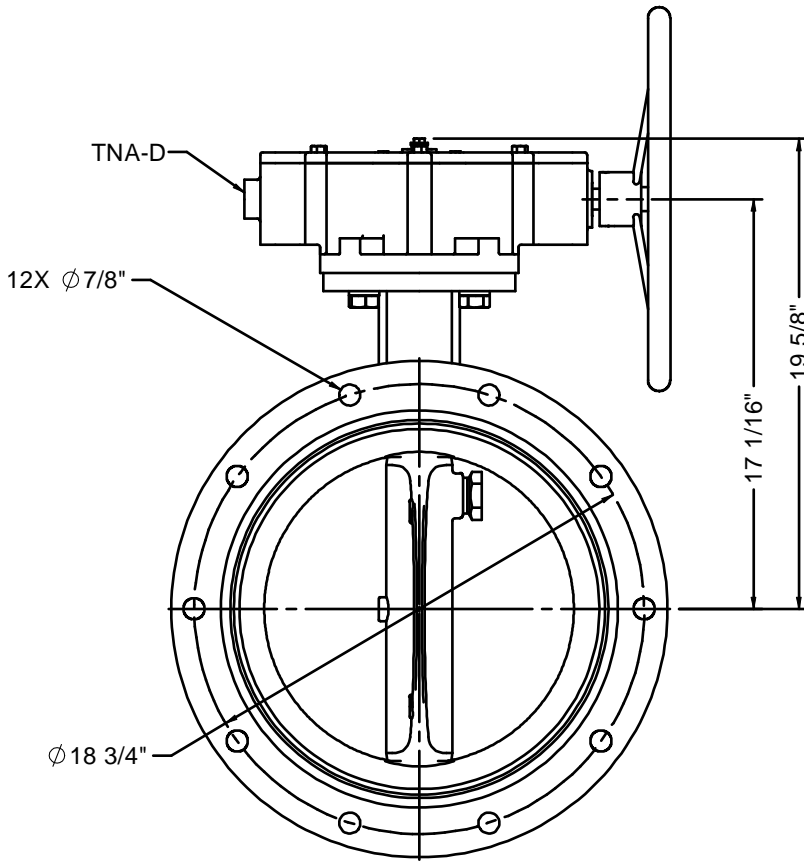
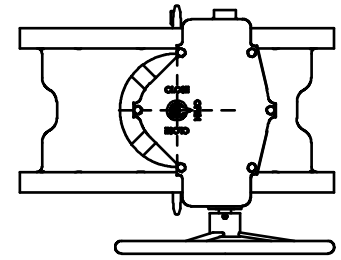

NOTES:

1. 250 PSIG MAXIMUM WORKING PRESSURE.
2. THIS VALVE CONFORMS TO AWWA C504.
3. MECHANICAL JOINT CONNECTION PER ANSI C111 AND AWWA A21.11.
4. ASTM A536 GR. 65-45-12 DUCTILE IRON BODY.
ASTM A536 GR. 65-45-12 DUCTILE IRON DISC WITH 316 SST EDGE.
ASTM A564 TYPE 630 (17-4PH) STAINLESS STEEL SHAFT.
5. VALVE IS DESIGNED FOR BI-DIRECTIONAL FLOW.
6. VALVE MAY BE INSTALLED WITH SHAFT IN EITHER HORIZONTAL OR VERTICAL POSITION.
7. ALL DIMENSIONS ARE IN INCHES.
8. VALVE DISC AND EXTERIOR WILL BE COATED WITH 8 MILS EPOXY.

K-FLO			
BUTTERFLY VALVES BY CRISPIN VALVES			
14"-506HP SERIES VALVE TNA OPERATOR			

REDRAWN:		SIZE	DWG. NO.	REV
CHECKED:		C	HW 14-506HP TNA	1
DRAWN: C. GEARY	02/17/10			