

# 18"-506 WITH TNA OPERATOR AND HANDWHEEL

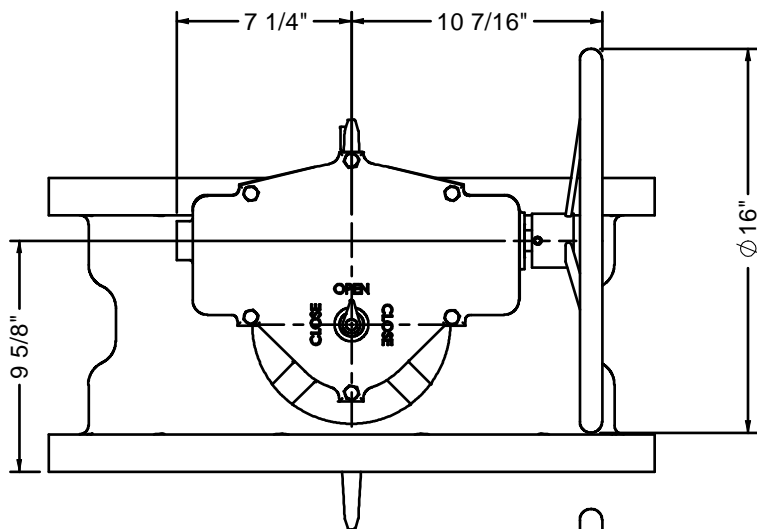

◆ OPTIONAL CONFIGURATION

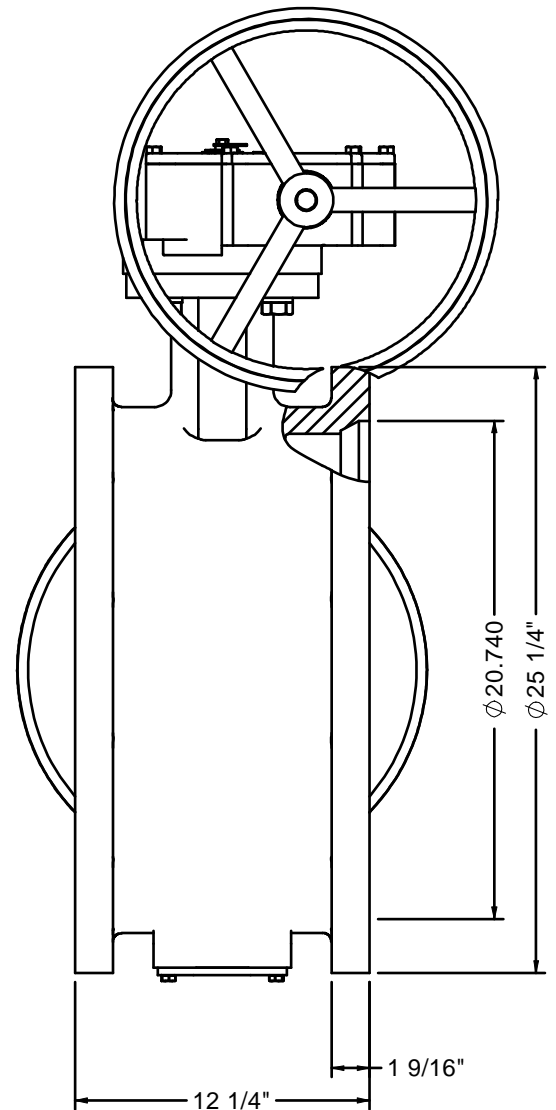
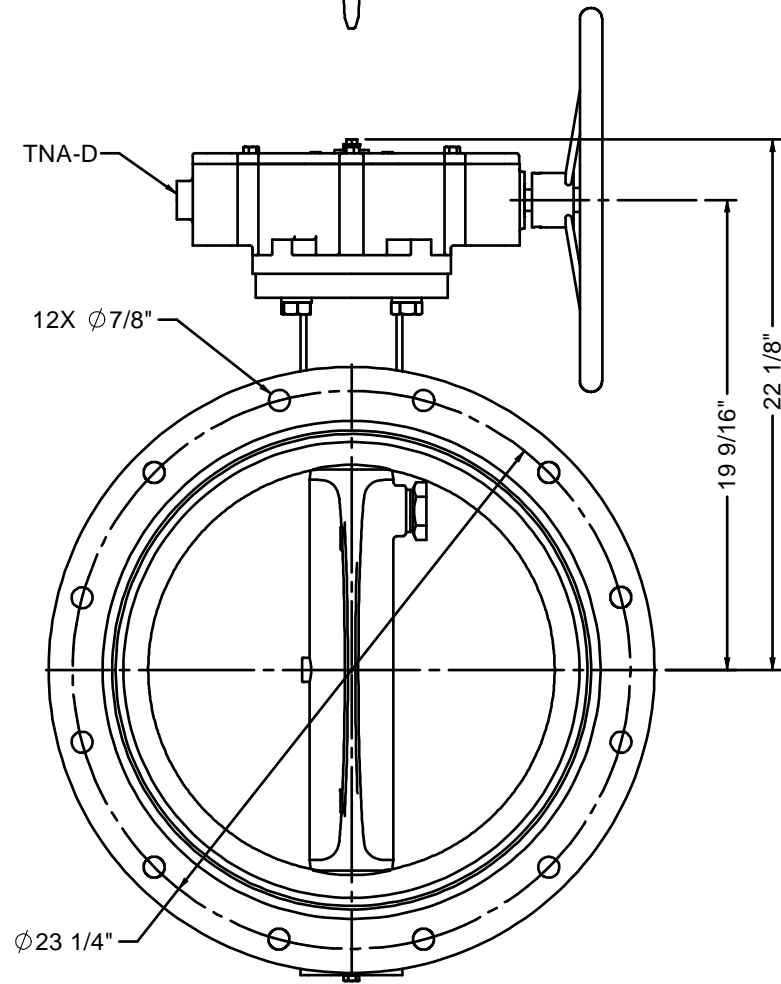
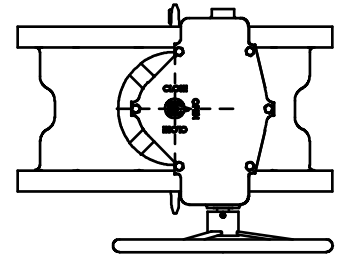

**NOTES:**

1. 150 PSIG MAXIMUM WORKING PRESSURE.
2. THIS VALVE CONFORMS TO AWWA C504.
3. MECHANICAL JOINT CONNECTION PER ANSI C111 AND AWWA A21.11.
4. ASTM A126 GL. B CAST IRON BODY.  
ASTM A536 GR. 65-45-12 DUCTILE IRON DISC WITH 316 SST EDGE.  
ASTM A276 TYPE 304 STAINLESS STEEL SHAFT.
5. VALVE IS DESIGNED FOR BI-DIRECTIONAL FLOW.
6. VALVE MAY BE INSTALLED WITH SHAFT IN EITHER HORIZONTAL OR VERTICAL POSITION.
7. ALL DIMENSIONS ARE IN INCHES.
8. VALVE DISC AND EXTERIOR WILL BE COATED WITH 8 MILS EPOXY.

**K-FLO**  
 BUTTERFLY VALVES  
 BY  
 CRISPIN VALVES  
 18"-506 SERIES  
 VALVE  
 TNA OPERATOR

REDRAWN:		SIZE	DWG. NO.	REV
CHECKED:		C	HW 18-506 TNA	1
DRAWN: C. GEARY	02/17/10			